

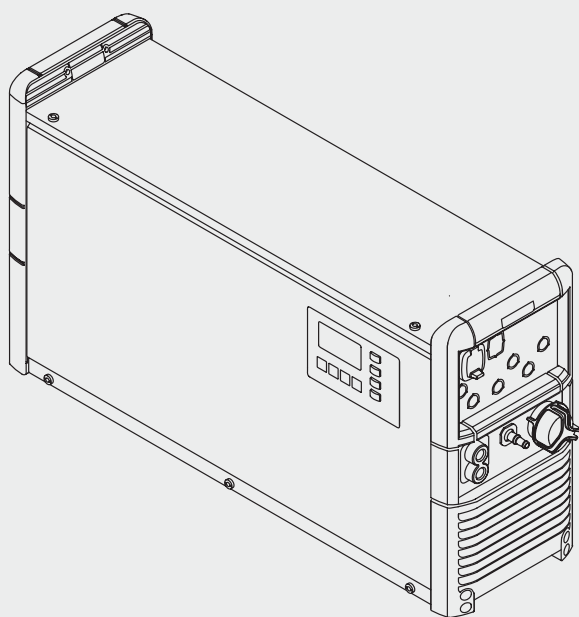

## QUICK INSTALLATION GUIDE Selectiva 8/16 kW



Vor Arbeiten mit dem Gerät, alle zur Verfügung gestellten Dokumente lesen und verstehen! Read and understand all provided documents before working with this device! ¡Antes de trabajar con el equipo, leer y comprender todos los documentos provistos! Avant d'utiliser l'appareil, assurez-vous d'avoir lu et compris tous les documents mis à votre disposition! Prima di lavorare con l'apparecchio, leggere e comprendere tutti i documenti messi a disposizione! Před zahájením práce s přístrojem je třeba přečíst všechny poskytnuté dokumenty a porozumět jejich obsahu! Før du jobber med apparatet, må du ha lest og forstått alle tilgjengelige dokumenter! Przed rozpoczęciem pracy z wykorzystaniem urządzenia należy zapoznać się z przekazanymi dokumentami! Leia e compreenda todos os documentos fornecidos antes de trabalhar com este dispositivo! Cihazla çalışmaya başlamadan önce sunulan tüm dokümanları okumalı ve anlamalısınız! Pred prácami so zariadením si musíte prečítať všetky dodané dokumenty a porozumieť im! Прежде чем приступить к работе с устройством, ознакомьтесь со всей сопутствующей документацией! 在使用此设备前务必阅读并理解所提供的文档!



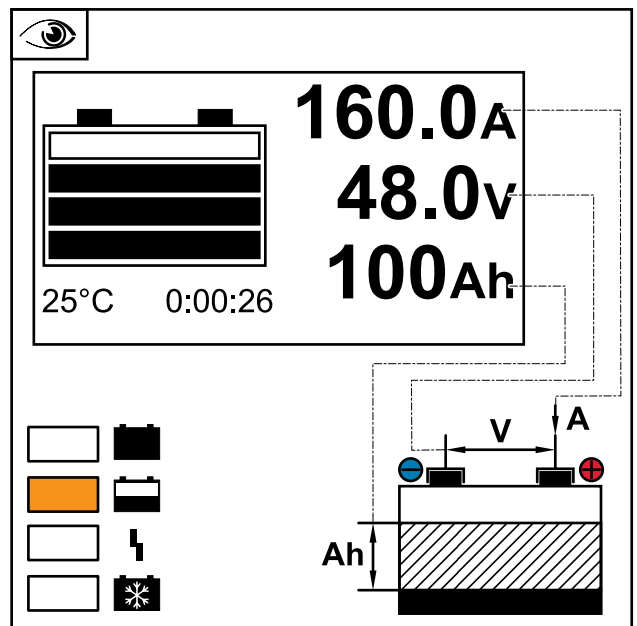
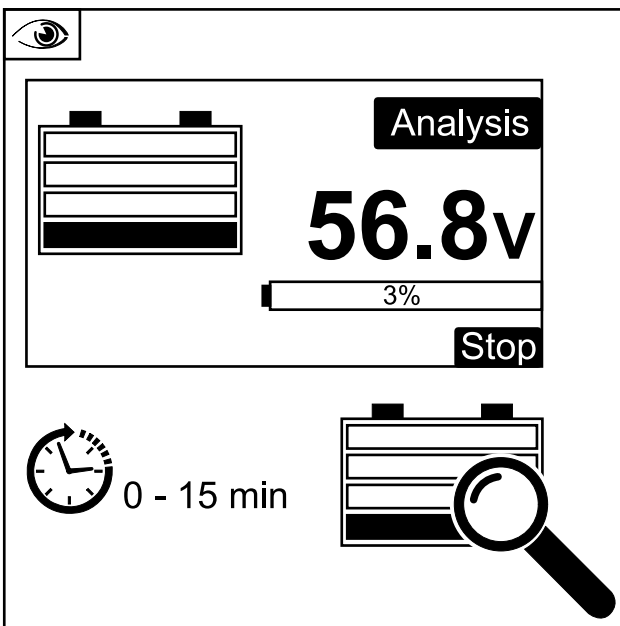
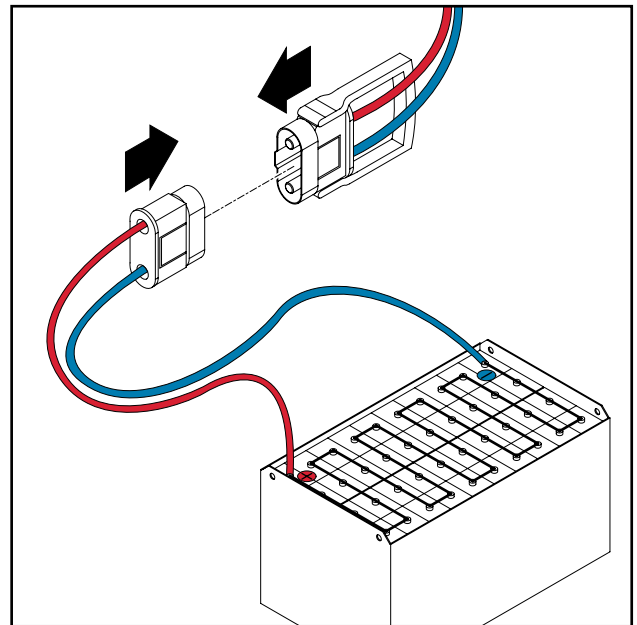
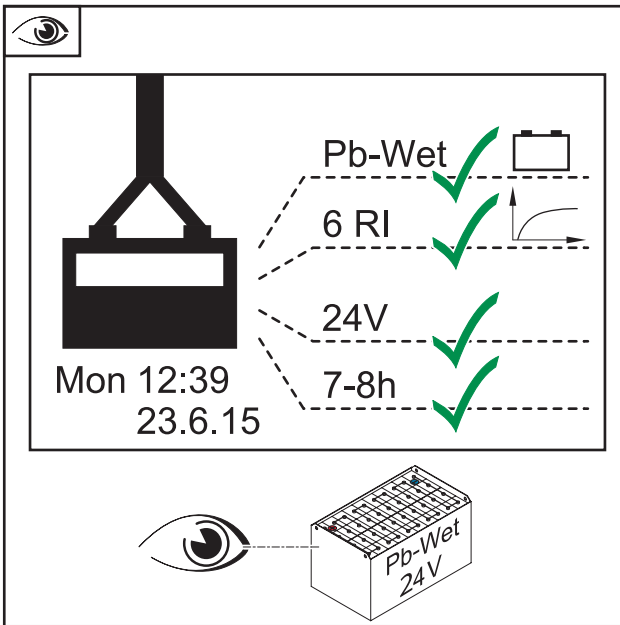
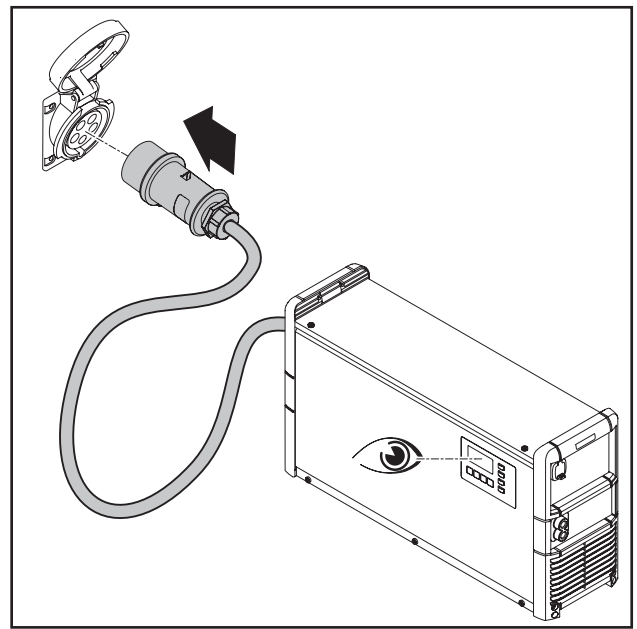
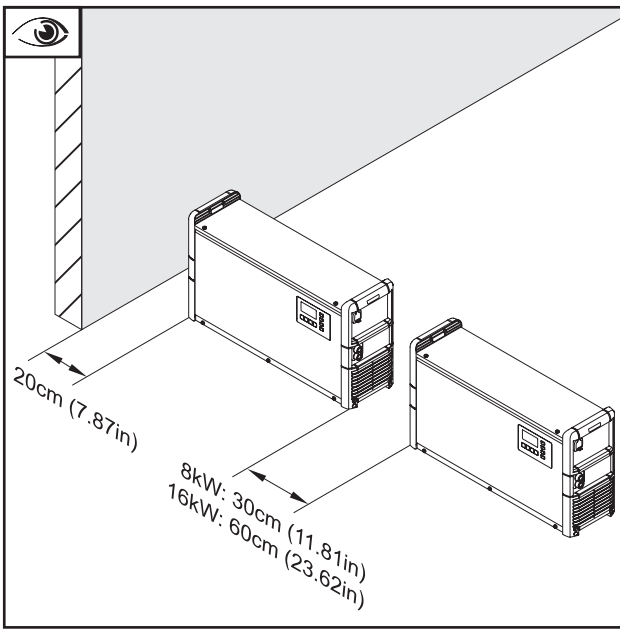

Finished charging since

# 10

min



Finished charging since

# 120

min

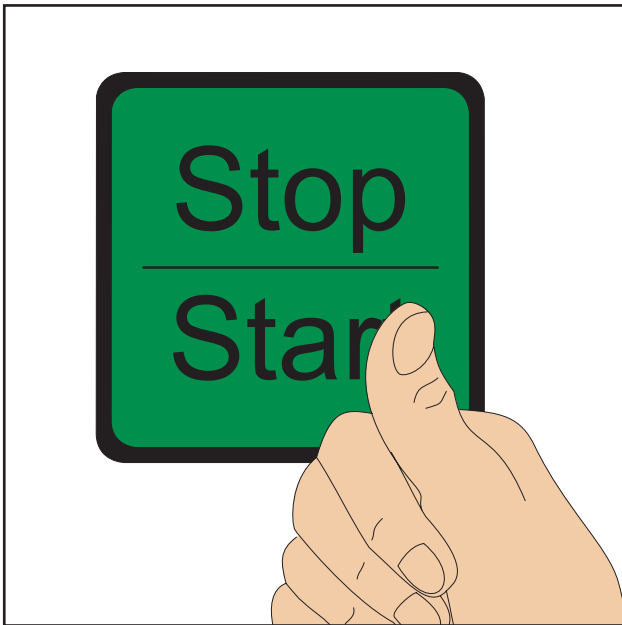
STOPPED





# 57.5v

# 0Ah

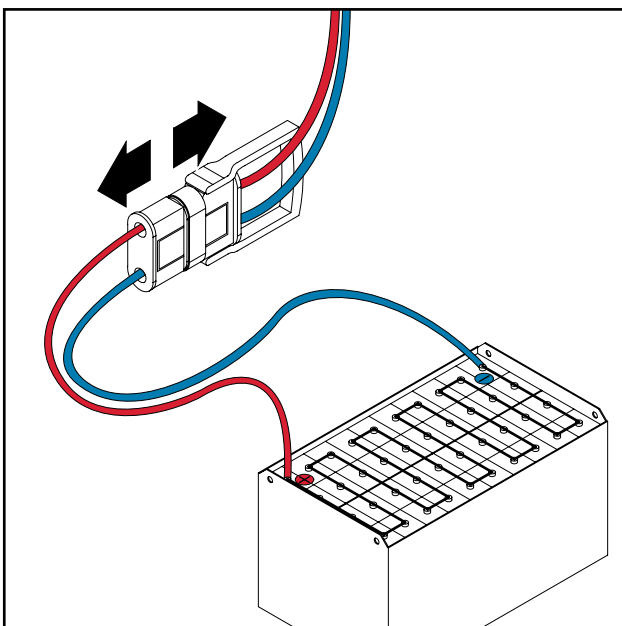
31°C

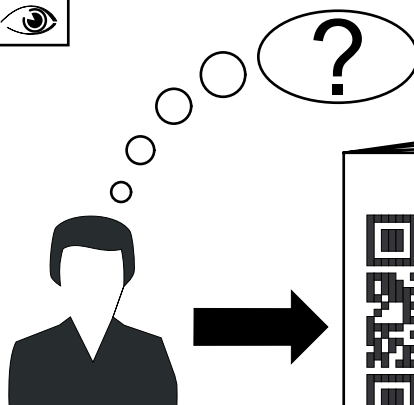

?

Manual

[www.fronius.com/charger-manuals](http://www.fronius.com/charger-manuals)

